

EX: A = JANUARY      EX: 6 = 2006

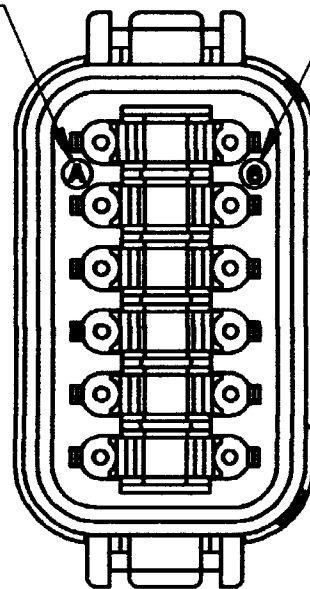

DATE CODE  
MONTH IS REPRESENTED BY SEQUENTIAL ALPHA CHARACTERS.  
YEAR IS REPRESENTED BY THE LAST NUMERICAL DIGIT.

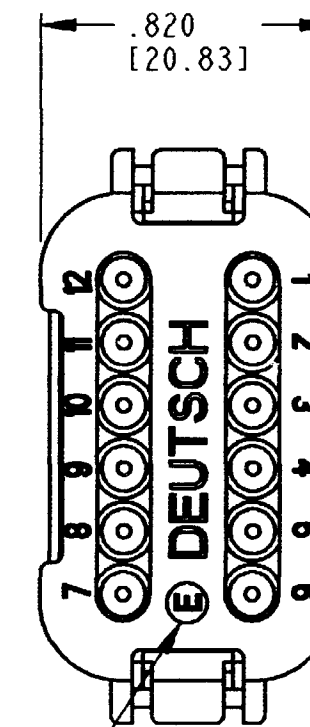
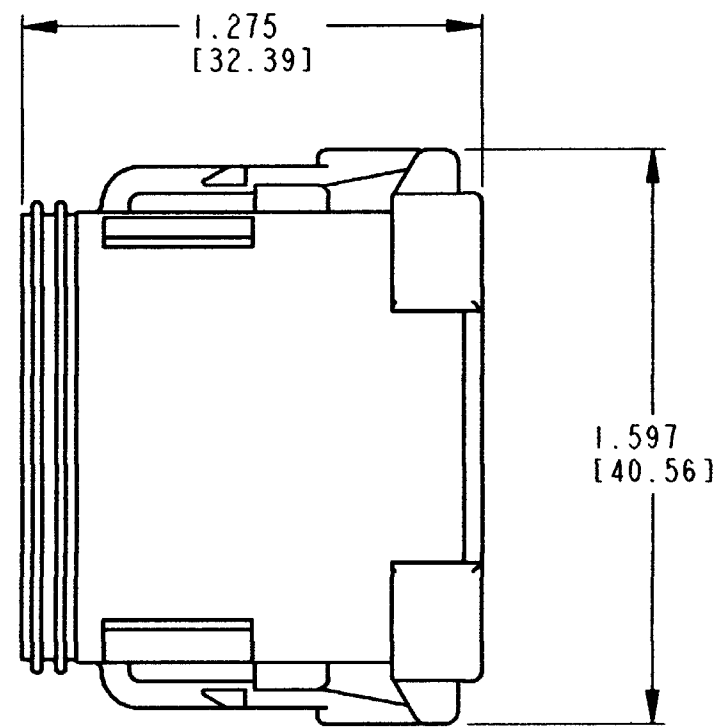

-E- DESIGNATES REDUCED WIRE SEAL

REV		REVISIONS		
NC	SYM	DESCRIPTION	DATE	APPROVED
NC		NEW RELEASE PER E.O. P19569	7/7/07	RDR

- 5. MATERIAL: SHELL: PLASTIC; SEAL: RUBBER.
- 4. THIS PLUG MATES WITH DT04-12P\*-\*-\* (\*\*\*\* = ALL MODIFICATIONS, \* = KEY ARR.). CONSULT FACTORY FOR MODIFICATIONS.
- 3. FOR CONTACTS AND WIRE PERFORMANCE AND APPLICATION CHARACTERISTICS SEE ENVELOPE DRAWINGS 0425-015-0000 AND 0425-017-0000.
- 2. DIMENSIONS ARE ±.025[0.63] UNLESS OTHERWISE SPECIFIED.
- 1. DIMENSIONS ARE IN INCHES [MILLIMETERS].

NOTES:

CONTACT SIZE	MIN. INSUL O.D.	MAX. INSUL O.D.	WIRE RANGE [mm <sup>2</sup> ]
16	.053 [1.35]	.120 [3.05]	14-20 AWG [2.0-0.5]

SIGNATURE & DATE	
DR	R. MESSENGER 7/12/07
CHK	[Signature] 7/14/07
PE	R. Messenger 7/16/07
APPD	[Signature] 7/16/07
SCALE	NONE WT

12 WAY PLUG  
REDUCED WIRE SEAL  
END CAP  
DT SERIES

ENVELOPE

EP	MATL. CODE
3850 INDUSTRIAL AVE. HEMET, CA 92545	
<b>B DT06-12S* -CE01</b>	
DWG SIZE	CODE 11139 SHEET 1 OF 2

REV NC	<b>DT06-12S*-CE01</b>	REVISIONS		
SYM	DESCRIPTION	DATE	APPROVED	
NC	NEW RELEASE PER E.O. P19569	7-17-07	ROR	

DT06-12SA-CE01  
KEY ARR. -A-  
COLOR: GRAY

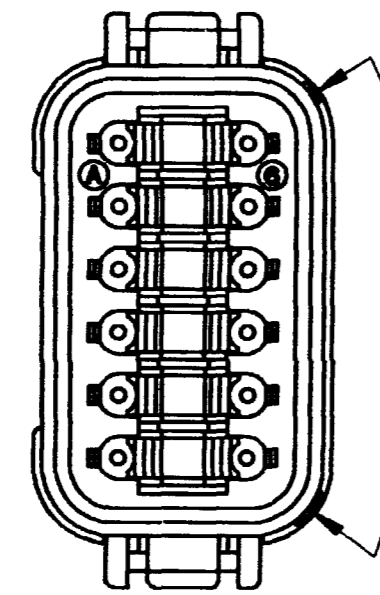

-A- KEYS

DT06-12SB-CE01  
KEY ARR. -B-  
COLOR: BLACK

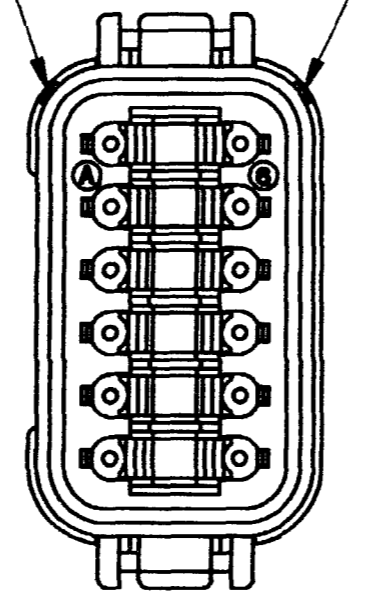

-B- KEYS

DT06-12SC-CE01  
KEY ARR. -C-  
COLOR: GREEN

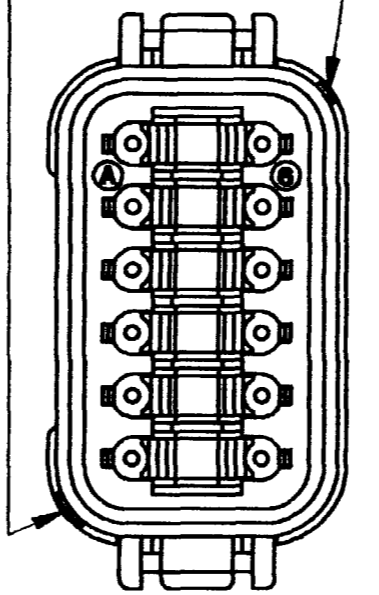

-C- KEYS

DT06-12SD-CE01  
KEY ARR. -D-  
COLOR: BROWN

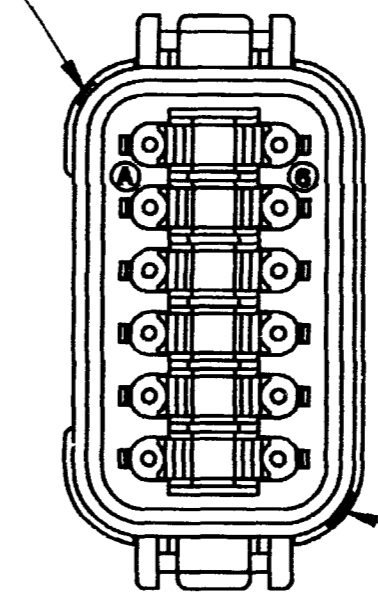

-D- KEYS

NOTES:

	SIGNATURE & DATE
DR	R. MESSENGER 7/12/07
CHK	[Signature] 7/16/07
PE	R. Messenger 7/12/07
APPD	[Signature] 7/13/07
SCALE	NONE WT

12 WAY PLUG  
REDUCED WIRE SEAL  
END CAP  
DT SERIES  
  
ENVELOPE

EP	MATL. CODE
<b>The Deutsch Company</b> DEUTSCH I.P.D. 3850 INDUSTRIAL AVE. HEMET, CALIF. 92545	
<b>B</b>	<b>DT06-12S*-CE01</b>
DWG SIZE	CODE 11139 SHEET 2 OF 2